

JVC

SERVICE MANUAL

COLOUR TELEVISION

BASIC CHASSIS

JK

AV28S2EKGR / AV28S2EKBL
AV28S2EIGR / AV28S2EIBL

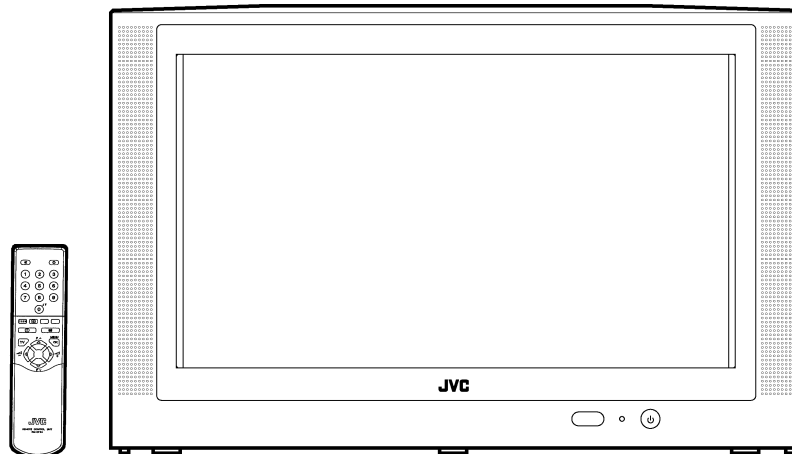

CONTENTS

■ SPECIFICATIONS	2
■ SAFETY PRECAUTIONS	4
■ WARNING	4
■ FEATURES	5
■ MAIN DIFFERENCE PARTS LIST	5
■ SPECIFIC SERVICE INSTRUCTIONS	6
■ SERVICE ADJUSTMENTS	12
■ PARTS LIST	31
★ OPERATING INSTRUCTIONS	1-1
★ STANDARD CIRCUIT DIAGRAM	2-1

SPECIFICATIONS

Item	Content	
	AV28S2EKGR AV28S2EKBL	AV28S2EIGR AV28S2EIBL
Dimensions (W × H × D)	800mm × 500mm × 496mm	←
Mass	41kg	←
TV RF System	CCIR (I)	←
Colour System	PAL / NTSC (Only in EXT mode)	←
Stereo System	NICAM (I)	←
Teletext System	FLOF (Fastext) WST(Standard system)	←
Receiving Frequency		
VHF	—————	47MHz ~ 470MHz
UHF	470MHz ~ 862MHz	470MHz ~ 862MHz
Intermediate Frequency		
VIF Carrier	38.9MHz (I)	←
SIF Carrier	32.9MHz (6.0MHz:I)	←
Colour Sub Carrier Freq.		
PAL	4.43MHz	←
NTSC	3.58MHz / 4.43MHz	←
Power Input	AC 220V~240V , 50Hz	←
Power Consumption	168W(Max) / 115W(Avg),	←
Aerial Input Term	75Ω unbalanced, Coaxial	←
Picture Tube	Visible size : 66cm, Measured diagonally	←
High Voltage	30.0kV ^{+1kV} _{-1.5kV} (at zero beam current)	←
Speaker	20cm × 4cm Oval type × 2	←
Audio Output	7.5W + 7.5W	←
EXT-1/EXT-2/EXT-3 (Input / Output)	21-pin Euro connector (SCART socket)	←
EXT-4 (Input)	Video 1Vp-p 75Ω (RCA pin jack) Audio(L/R) 500mVrms(-4dBs), High Impedance (RCA pin jack) S / Video Y : 1Vp-p POSITIVE (Negative sync Provided, when terminated with 75Ω) C : 0.286Vp-p (Burst signal, when terminated with 75Ω)	←
AUDIO OUT (Variable)	0~1Vrms, Low Impedance (RCA pin jack × 2)	←
Headphone jack	Stereo mini jack (φ 3.5mm)	←
Remote Control Unit	RM-C55 (AAA/R03 dry battery × 2)	←

Design & specifications are subject to change without notice.

■ 21-pin Euro connector (SCART socket) : EXT-1 / EXT-2 / EXT-3

(P-P= Peak to Peak, S-W= Sync tip to white peak, B-W= Blanking to white peak)

Pin No.	Signal Designation	Matching Value	EXT-1	EXT-2	EXT-3
1	AUDIO R output	500mVrms(Nominal), Low impedance	○ (TV OUT)	○ (LINE OUT)	NC
2	AUDIO R input	500mVrms(Nominal), High impedance	○	○	○
3	AUDIO L output	500mVrms(Nominal), Low impedance	○ (TV OUT)	○ (LINE OUT)	NC
4	AUDIO GND		○	○	○
5	GND (B)		○	○	○
6	AUDIO L input	500mVrms(Nominal), High impedance	○	○	○
7	B input	700mV _{B-W} , 75Ω	○	NC	NC
8	FUNCTION SW (SLOW SW)	Low : 0-3V, High : 8-12V, High impedance	○	○	○
9	GND (G)		○	○	○
10	SCL3		NC	○	NC
11	G input	700mV _{B-W} , 75Ω	○	NC	NC
12	SDA3		NC	○	NC
13	GND (R)		○	○	○
14	GND (Y _S)		○	NC	NC
15	R / C input	R : 700mV _{B-W} , 75Ω C : 300mV _{P-P} , 75Ω	○ (only R)	○ (only C)	○ (only C)
16	Ys input	Low : 0 - 0.4, High : 1 - 3V, 75Ω	○	NC	NC
17	GND(VIDEO output)		○	○	○
18	GND(VIDEO input)		○	○	○
19	VIDEO output	1V _{P-P} (Negative going sync), 75Ω	○ (TV)	○ (LINE OUT)	NC
20	VIDEO / Y input	1V _{P-P} (Negative going sync), 75Ω	○	○	○
21	COMMON GND		○	○	○

[Pin assignment]

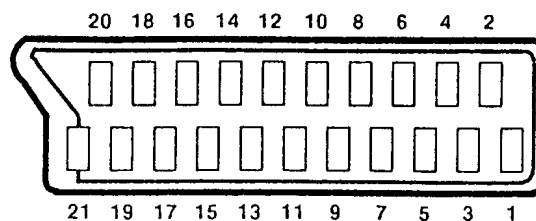

SAFETY PRECAUTIONS

1. The design of this product contains special hardware and many circuits and components specially for safety purposes. For continued protection, no changes should be made to the original design unless authorized in writing by the manufacturer. Replacement parts must be identical to those used in the original circuits. Service should be performed by qualified personnel only.
2. Alterations of the design or circuitry of the product should not be made. Any design alterations or additions will void the manufacturer's warranty and will further relieve the manufacturer of responsibility for personal injury or property damage resulting therefrom.
3. Many electrical and mechanical parts in the product have special safety-related characteristics. These characteristics are often not evident from visual inspection nor can the protection afforded by them necessary be obtained by using replacement components rated for higher voltage, wattage, etc. Replacement parts which have these special safety characteristics are identified in the Parts List of Service Manual. Electrical components having such features are identified by shading on the schematics and by (Δ) on the Parts List in the Service Manual. The use of a substitute replacement which does not have the same safety characteristics as the recommended replacement part shown in the Parts List of Service Manual may cause shock, fire, or other hazards.
4. The leads in the products are routed and dressed with ties, clamps, tubing's, barriers and the like to be separated from live parts, high temperature parts, moving parts and / or sharp edges for the prevention of electric shock and fire hazard. When service is required, the original lead routing and dress should be observed, and it should be confirmed that they have been returned to normal, after re-assembling.

WARNING

1. The equipment has been designed and manufactured to meet international safety standards.
2. It is the legal responsibility of the repairer to ensure that these safety standards are maintained.
3. Repairs must be made in accordance with the relevant safety standards.
4. It is essential that safety critical components are replaced by approved parts.
5. If mains voltage selector is provided, check setting for local voltage.

FEATURES

- By preference, users can select the picture size from REGULAR, PANORAMIC, FULL, 14:9 ZOOM, 16:9 ZOOM, 16:9 ZOOM SUB TITLE modes. When the TV unit received WSS picture signal, the picture can be changed to 16:9 ZOOM mode automatically.
- The TELETEXT SYSTEM has a built-in FASTEXT and WST system.
- Because this TV unit corresponds to multiplex broadcast, users can enjoy music programs and sporting events with live realism. In addition, BILINGUAL programs can be heard in their original language.
- Built-in ECO (ECONOMY, ECOLOGY) MODE.
In accordance with the brightness in a room, the brightness and/or contrast of the picture can be adjusted automatically to make the optimum picture which is easy on the eye.
- Users can make VCR dubbing of picture and sound by controlling the AV selector to select an optional source at the EXT-2 output shown in figure.

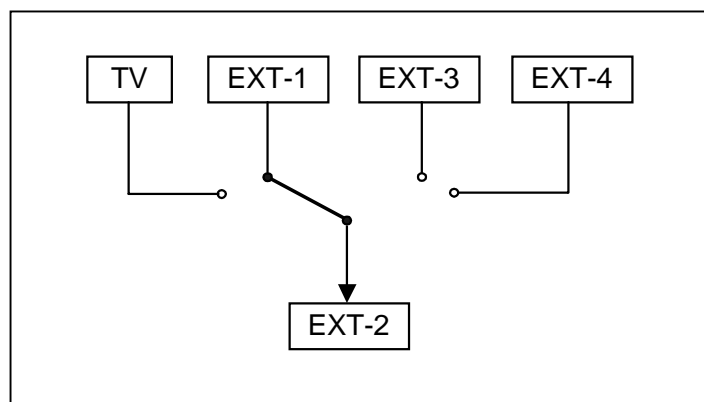

MAIN DIFFERENCE PARTS LIST

△	Model Name	AV28S2EKGR	AV28S2EKBL	AV28S2EIGR	AV28S2EIBL
	Part Name				
	MAIN PWB	SJK-1911A-U2	←	SJK-1711A-U2	←
	AV SEL. PWB	SJK0S911A-U2	←	SJK0S711A-U2	←
△	RATING LABEL	LC20091-020A-U	LC20091-025A-U	LC20091-039A-U	LC20091-040A-U
	EURO LABEL	AEM1052-016-E	AEM1052-015-E	AEM1052-013-E	AEM1052-002-E
△	INST BOOK	LCT0895-001A-U	←	LCT0896-001A-U	←
	REG. SHEET	AEM3148-001-E	←	x	←
	REMOCON WINDOW	LC31203-001A-C	LC31203-001B-C	LC31203-001A-C	LC30203-001B-C
	FRONT FRAME	LC11007-001B-U	LC11007-002B-U	LC11007-001B-U	LC11007-002B-U

SPECIFIC SERVICE INSTRUCTIONS

DISASSEMBLY PROCEDURE

REMOVING THE REAR COVER

1. Unplug the power cord.
2. Remove the 10 screws marked "A" as shown in the Fig. 1.
3. Withdraw the rear cover toward you.

REMOVING THE SIDE CONTROL JACK ASSEMBLY

- After removing the rear cover.
1. Remove the screw marked B as shown in the Fig.1.
 2. While slightly raise the side control jack assembly, remove the 2 claws under the side control jack assembly.
 3. Disconnect the connector "SR", "SL", "S", "F" and "K" as shown in Fig 2.

REMOVING THE SIDE CONTROL PWB

- After removing the rear cover and side control jack assembly.
1. Remove the 3 claws "C" from back side of the side control jack assembly as shown in Fig.2.
 2. Pull out the SIDE CONTROL PWB.

REMOVING THE CHASSIS

- After removing the rear cover.
1. Slightly raise the both sides of the chassis by hand and remove the two claws under the both sides of the chassis from the front cabinet.
 2. Withdraw the chassis backward.
(If necessary, take off the wire clamp, connectors etc.)

REMOVING THE SPEAKER BOX

- After removing the rear cover.
1. Remove the 2 screws marked "D" as shown in Fig. 1.
- NOTE :** When removing the screws marked D of the speaker box assembly, remove the lower side screw first, and then remove the upper one.
2. Remove the 2 screws "E" attaching the speaker box.
 3. Remove the 2 screws "F" attaching the speaker.
 4. Follow the same steps when removing the other hand speaker.

REMOVING THE AV TERMINAL BOARD

- After removing the rear cover.
1. Remove the 3 screws marked "G" as shown in the Fig. 1.
 2. Remove the claws marked "H" under the CHASSIS as shown in Fig. 3.
 3. While raising the claw marked "I", remove the top of the AV TERMINAL BOARD slightly in the direction of arrow "J" as shown in Fig. 3.

CHECKING THE PW BOARD

To check the back side of the PW Board.

- 1) Pull out the chassis. (Refer to REMOVING THE CHASSIS).
- 2) Erect the chassis vertically so that you can easily check the back side of the PW Board.

[CAUTION]

- When erecting the chassis, be careful so that there will be no contacting with other PW Board.
- Before turning on power, make sure that the wire connector is properly connected.
- When conducting a check with power supplied, be sure to confirm that the CRT EARTH WIRE (BRAIDED ASS'Y) is connected to the CRT SOCKET PW board.

WIRE CLAMPING AND CABLE TYING

1. Be sure to clamp the wire.
2. Never remove the cable tie used for tying the wires together.
Should it be inadvertently removed, be sure to tie the wires with a new cable tie.

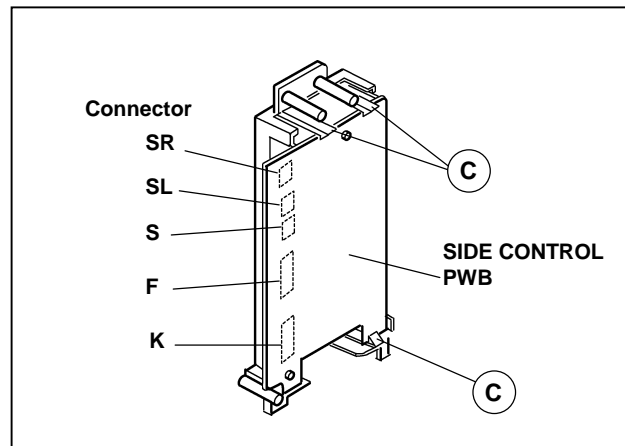

Fig. 2

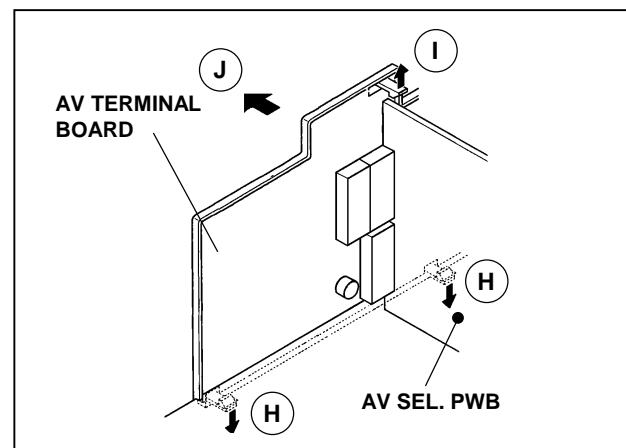

Fig. 3

REMOVING THE CRT

* Replacement of the CRT should be performed by 2 or more persons.

- After removing the cover, chassis etc.,
- 1. Putting the CRT change table on soft cloth, the CRT change table should also be covered with such soft cloth (shown in Fig.4).
- 2. While keeping the surface of CRT down, mount the TV set on the CRT change table balanced will as shown in Fig.5.
- 3. Remove 4 screws marked by arrows with a box type screw driver as shown in Fig.5.
- Since the cabinet will drop when screws have been removed, be sure to support the cabinet with hands.
- 4. After 4 screws have been removed, put the cabinet slowly on cloth (At this time, be carefully so as not to damage the front surface of the cabinet) shown in Fig.6.
- The CRT should be assembled according to the opposite sequence of its dismantling steps.

* The CRT change table should preferably be smaller than the CRT surface, and its height be about 35cm.

* About CRT Spacer

An appropriate CRT spacer should be used in the corresponding CRT in accordance with the type of the CRT.

When a CRT is replaced, special attention should be paid to this matter.

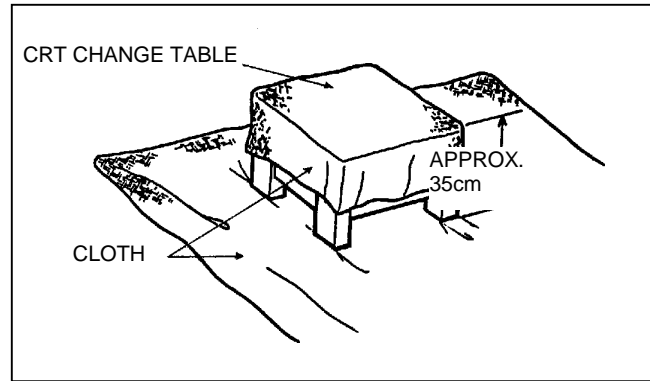

Fig. 4

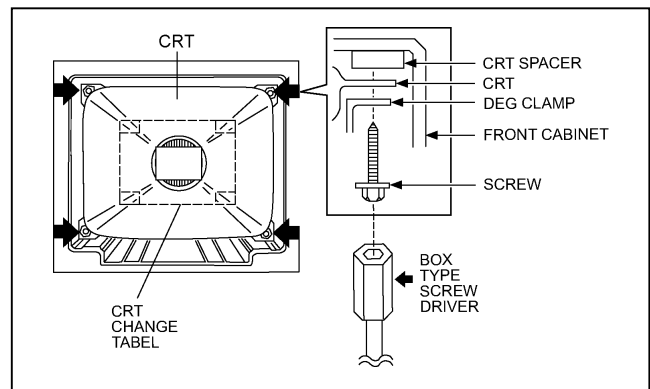

Fig. 5

COATING OF SILICON GREASE FOR ELECTRICAL INSULATION ON THE CRT ANODE CAP SECTION.

- Subsequent to replacement of the CRT and HV transformer or repair of the anode cap, etc. by dismantling them, be sure to coat silicon grease for electrical insulation as shown in Fig.7. Wipe around the anode button with clean and dry cloth. (Fig.7) Coat silicon grease on the section around the anode button. At this time, take care so that any silicon greases dose not stick to the anode button. (Fig.8)

★ Silicon grease product No. KS - 650N

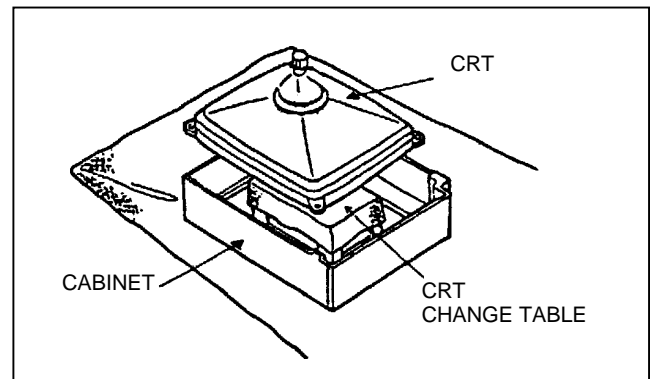

Fig. 6

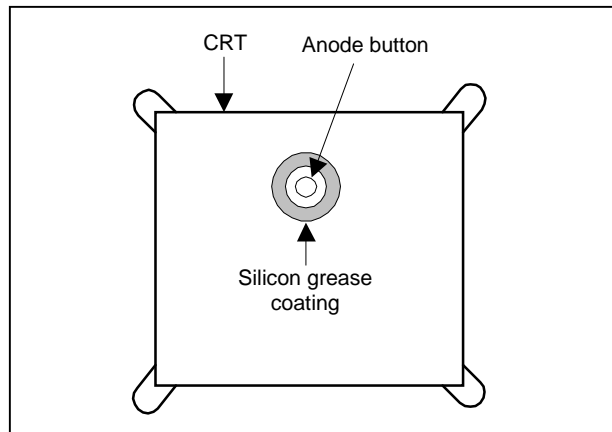

Fig. 7

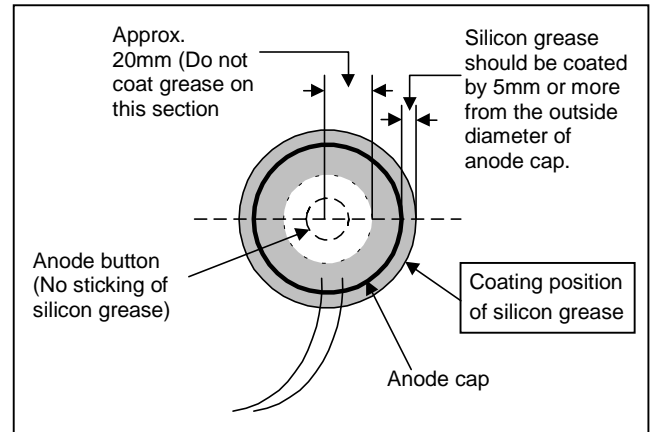

Fig. 8

REPLACEMENT OF CHIP COMPONENT

■ CAUTIONS

1. Avoid heating for more than 3 seconds.
2. Do not rub the electrodes and the resist parts of the pattern.
3. When removing a chip part, melt the solder adequately.
4. Do not reuse a chip part after removing it.

■ SOLDERING IRON

1. Use a high insulation soldering iron with a thin pointed end of it.
2. A 30w soldering iron is recommended for easily removing parts.

■ REPLACEMENT STEPS

1. How to remove Chip parts

◆ Resistors, capacitors, etc

- (1) As shown in the figure, push the part with tweezers and alternately melt the solder at each end.

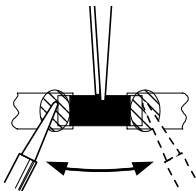

- (2) Shift with tweezers and remove the chip part.

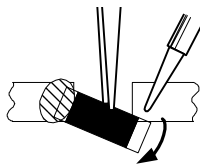

◆ Transistors, diodes, variable resistors, etc

- (1) Apply extra solder to each lead.

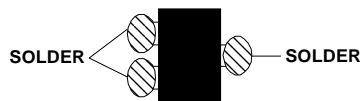

- (2) As shown in the figure, push the part with tweezers and alternately melt the solder at each lead. Shift and remove the chip part.

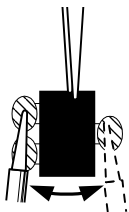

Note : After removing the part, remove remaining solder from the pattern.

2. How to install Chip parts

◆ Resistors, capacitors, etc

- (1) Apply solder to the pattern as indicated in the figure.

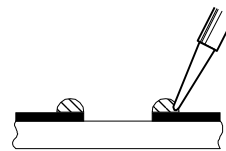

- (2) Grasp the chip part with tweezers and place it on the solder. Then heat and melt the solder at both ends of the chip part.

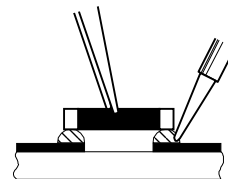

◆ Transistors, diodes, variable resistors, etc

- (1) Apply solder to the pattern as indicated in the figure.
- (2) Grasp the chip part with tweezers and place it on the solder.
- (3) First solder lead **A** as indicated in the figure.

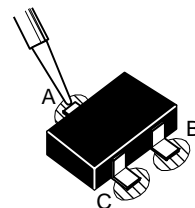

- (4) Then solder leads **B** and **C**.

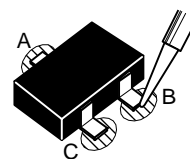

REPLACEMENT OF MEMORY ICs

1. Memory ICs

This TV use memory ICs. In the memory ICs, there are memorized data for correctly operating the video and deflection circuits. When replacing memory ICs, be sure to use ICs written with the initial values of data.

2. Procedure for replacing memory ICs

PROCEDURE	
(1) Power off	Switch the power off and unplug the power cord from the wall outlet.
(2) Replace ICs.	Be sure to use memory ICs written with the initial data values.
(3) Power on	Plug the power cord into the wall outlet and switch the power on.
(4) Check and set SYSTEM CONSTANT SET:	<p>* It must not adjust without signal.</p> <ol style="list-style-type: none"> 1) Press the INFORMATION key and the MUTING key of the REMOTE CONTROL UNIT simultaneously. 2) The SERVICE MENU screen of Fig. 1 will be displayed. 3) While the SERVICE MENU is displayed, press the INFORMATION key and MUTING key simultaneously, and the SYSTEM CONSTANT SET screen of Fig. 2 will be displayed. 4) Check the setting values of the SYSTEM CONSTANT SET of Table 1. If the value is different, select the setting item with the FUNCTION UP/DOWN key, and set the correct value with the FUNCTION +/- key. 5) Press the MENU key to memorize the setting value. 6) Press the INFORMATION key twice, and return to the normal screen.
(5) Setting of receive channels	<p>Set the receive channel. For setting, refer to the OPERATING INSTRUCTIONS.</p>
(6) User settings	<p>Check the user setting values of Table 2, and if setting value is different, set the correct value. For setting, refer to the OPERATING INSTRUCTIONS.</p>
(7) Setting of SERVICE MENU	<p>Verify the setting items of the SERVICE MENU of Table 3, and reset where necessary. For setting, refer to the SERVICE ADJUSTMENTS.</p>

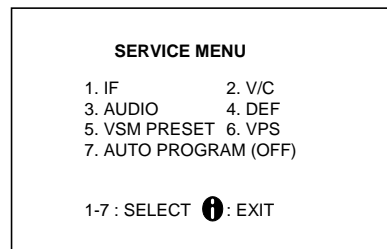

Fig.1

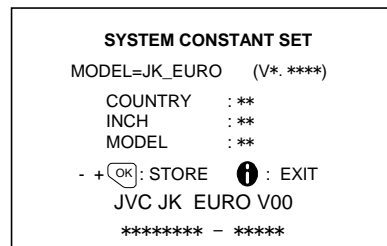

Fig.2

NAME OF REMOTE CONTROL KEY

Names of key	key
INFORMATION	
MUTING	
MENU	
FUNCTION UP/DOWN	
FUNCTION +/-	

SETTING VALUES OF SYSTEM CONSTANT SET (TABLE 1)

Setting item	Setting content	Setting value	
		AV28S2EKGR AV28S2EKBL	AV28S2EIGR AV28S2EIBL
COUNTRY	→ EK → EN → EP → EE → IR →	EK	IR
INCH	→ 28 → 32 →	28	28
MODEL	→ WFT → WFR →	WFT	←

USER SETTING VALUES (TABLE 2)

PICTURE SETTING		EXT SETTING	
TINT CONTRAST BRIGHT SHARP COLOUR ECO MODE	COOL REFER to VSM PRESET REFER to VSM PRESET REFER to VSM PRESET OFF	EXT SETTING DUBBING	ID : BLACK S-IN : BLACK EXT-1→EXT-2
PICTURE FEATURES		FEATURES	
VNR COLOUR SYSTEM 4:3 AUTO ASPECT	AUTO TV : According to preset CH EXT : AUTO PANORAMIC	SLEEP TIMER BLUE BACK CHILD LOCK DECODER (EXT-2)	OFF ON ID : No.**** ALL CH : OFF OFF
SOUND SETTING		INSTALL	
BASS TREBLE BALANCE BBE HYPER SOUND SPEAKER	CENTER CENTER CENTER ON OFF L/R	LANGUAGE EDIT	ENGLISH PRESET CH only The others : BLANK

SERVICE MENU SETTING ITEMS (TABLE 3)

Setting item	Setting value	Setting item	Setting value
1. IF	VCO	4. DEF.	1. V-SHIFT 2. V-SIZE 3. SUBTITLE 4. H-CENT 5. H-SIZE 6. EW-PIN 7. TRAPEZ 8. EW. COR. L 9. EW. COR. H 10. V. S-COR 11. V- LIN 12. H-BLK-R 13. H-BLK-L 14. V-EHT 15. H-EHT 16. EHT-GAIN
2. V / C	1. CUT OFF 2. DRIVE 3. BRIGHT 4. CONT. 5. COLOUR 6. HUE 7. BLACK OFFSET (Only SECAM) 8. SHARP 9. PURITY	5. VSM PRESET [COOL NORMAL WARM	1. BRIGHT 2. CONT. 3. COLOUR 4. SHARP 5. HUE 6. R DRIVE 7. B DRIVE
1. AUDIO (Do not adjust)	1. CONC LIMIT 2. A2 ID THR 3. ALC 4. BASS 5. TREBLE	6. VPS (Do not adjust)	VPS PDC
		7. AUTO PROGRAM (Do not adjust)	ON / OFF

SERVICE ADJUSTMENTS

BEFORE STARTING SERVICE ADJUSTMENT

1. There are 2 ways of adjusting this TV: One is with the REMOTE CONTROL UNIT and the other is the conventional method using adjustment parts and components.
2. The setting (adjustment) using the REMOTE CONTROL UNIT is made on the basis of the initial setting values. The setting values which adjust the screen to the optimum condition can be different from the initial setting values.
3. Make sure that connection is correctly made to AC power source.
4. Turn on the power of the TV and measuring instrument for warming up for at least 30 minutes before starting adjustment.
5. If the receive or input signal is not specified, use the most appropriate signal for adjustment.
6. Never touch parts (such as variable resistors, transformers and condensers) not shown in the adjustment items of this service adjustment.
7. Preparation for adjustment (presetting):
Unless otherwise specified in the adjustment items, preset the following functions with the REMOTE CONTROL UNIT:

- Setting position

PICTURE MODE (VSM)	NORMAL
SLEEP TIMER	OFF
BALANCE	CENTER
ECO	OFF
ZOOM	PANORAMIC

MEASURING INSTRUMENT AND FIXTURES

1. DC voltmeter (or digital voltmeter)
2. Oscilloscope
3. Signal generator (Pattern generator) [PAL / NTSC]
4. Remote control unit

ADJUSTMENT ITEMS

- Checking items.
- Adjustment of FOCUS.
- IF circuit adjustment.
- VSM preset setting.
- VIDEO / CHROMA circuit adjustment.
- DEFLECTION circuit adjustment.
- H. BLANKING ADJUSTMENT.
- AUDIO circuit adjustment. (Do not adjust)

ADJUSTMENT LOCATIONS

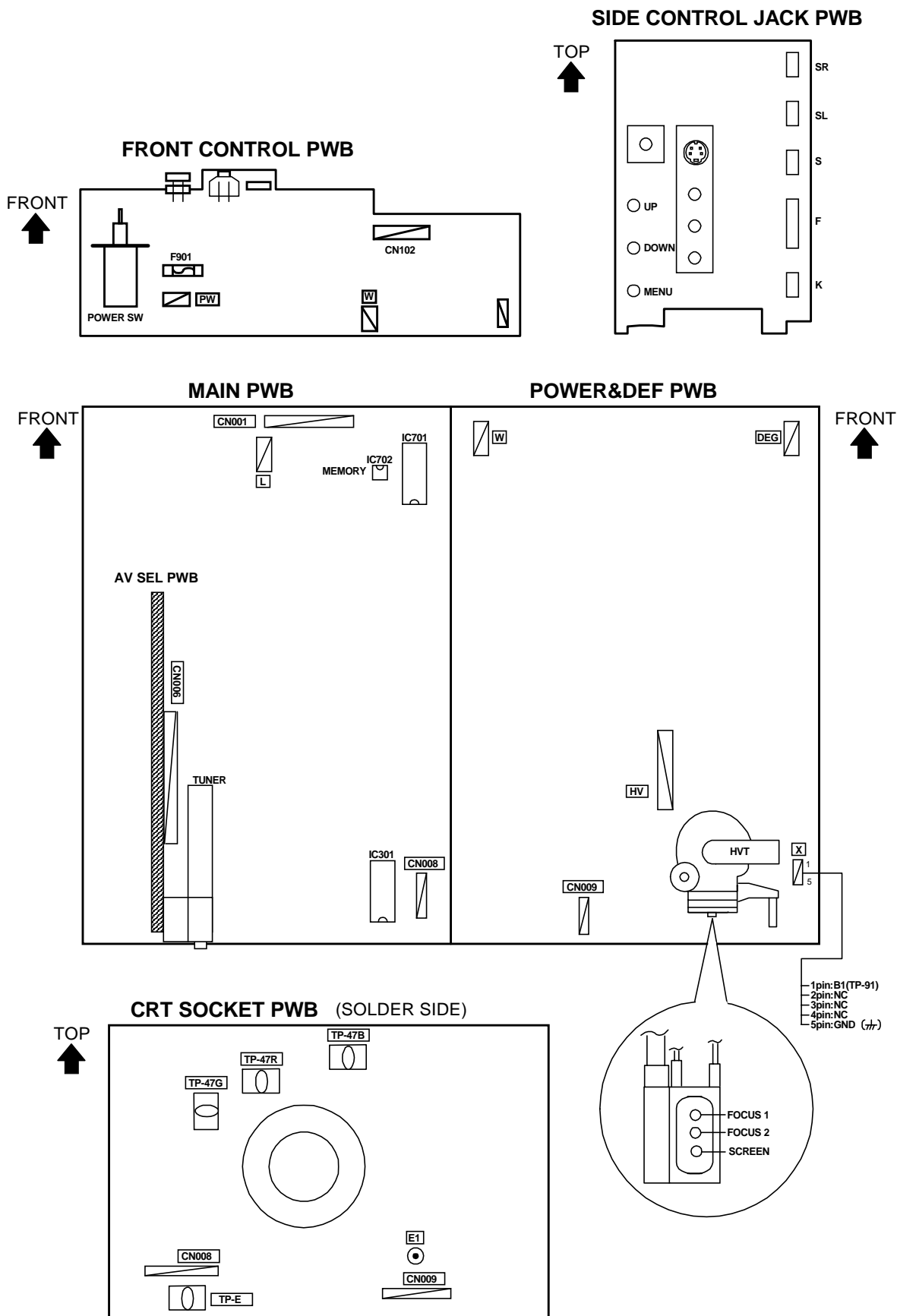

BASIC OPERATION SERVICE MENU

1. TOOL OF SERVICE MENU OPERATION

Operate the SERVICE MENU with the REMOTE CONTROL UNIT.

2. SERVICE MENU ITEMS

With the SERVICE MENU, various settings (adjustments) can be made, and they are broadly classified in the following items of settings (adjustments):

- (1) **1. IF** This mode adjusts the setting values of the IF circuit.
- (2) **2.V/C** This mode adjusts the setting values of the VIDEO / CHROMA circuit.
- (3) **3.AUDIO** This mode adjusts the setting values of the multiplicity SOUND circuit.
- (4) **4.DEF** This mode adjusts the setting values of the DEFLECTION circuit for each aspect mode given below.
 - REGULAR (50/60Hz)
 - PANORAMIC (50/60Hz)
 - 14:9 ZOOM (50/60Hz)
 - 16:9 ZOOM (50/60Hz)
 - 16:9 ZOOM SUB TITLE (50/60Hz)
 - FULL (50/60Hz)
- (5) **5.VSM PRESET** This mode adjusts the initial setting values of COOL,NOMAL and WARM.
 (VSM : Video Status Memory)
- (6) **6.VPS** This mode shows the monitor of the VPS and PDC. **(Do not adjust)**.
 (VPS : Video Program System, PDC : Program Delivery Code)
- (7) **7.AUTO PROGRAM** By turning the power switch on, you can get the state of AUTO PROGRAM. **(Do not adjust)**

3. BASIC OPERATION OF SERVICE MENU

(1) How to enter SERVICE MENU

Press the INFORMATION key and the MUTING key of the REMOTE CONTROL UNIT simultaneously, and the SERVICE MENU screen of Fig. 1 will be displayed.

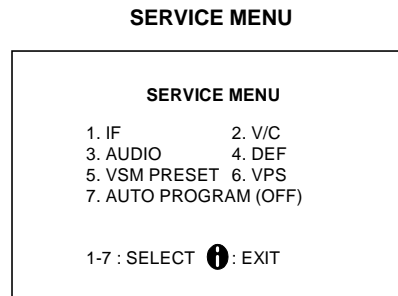

Fig.1

(2) Selection of SUB MENU SCREEN

Press one of keys 1~7 of the REMOTE CONTROL UNIT and select the SUB MENU SCREEN (See Fig. 3), form the SERVICE MENU.

SERVICE MENU → SUB MENU

- 1. IF
- 2. V / C
- 3. AUDIO
- 4. DEF.
- 5. VSM PRESET
- 6. VPS
- 7. AUTO PROGRAM

NEME OF REMOTE CONTOROL KEY

Names of key	key
INFORMATION	
MUTING	
MENU	
FUNCTION UP/DOWN	
FUNCTION +/-	

Fig.2

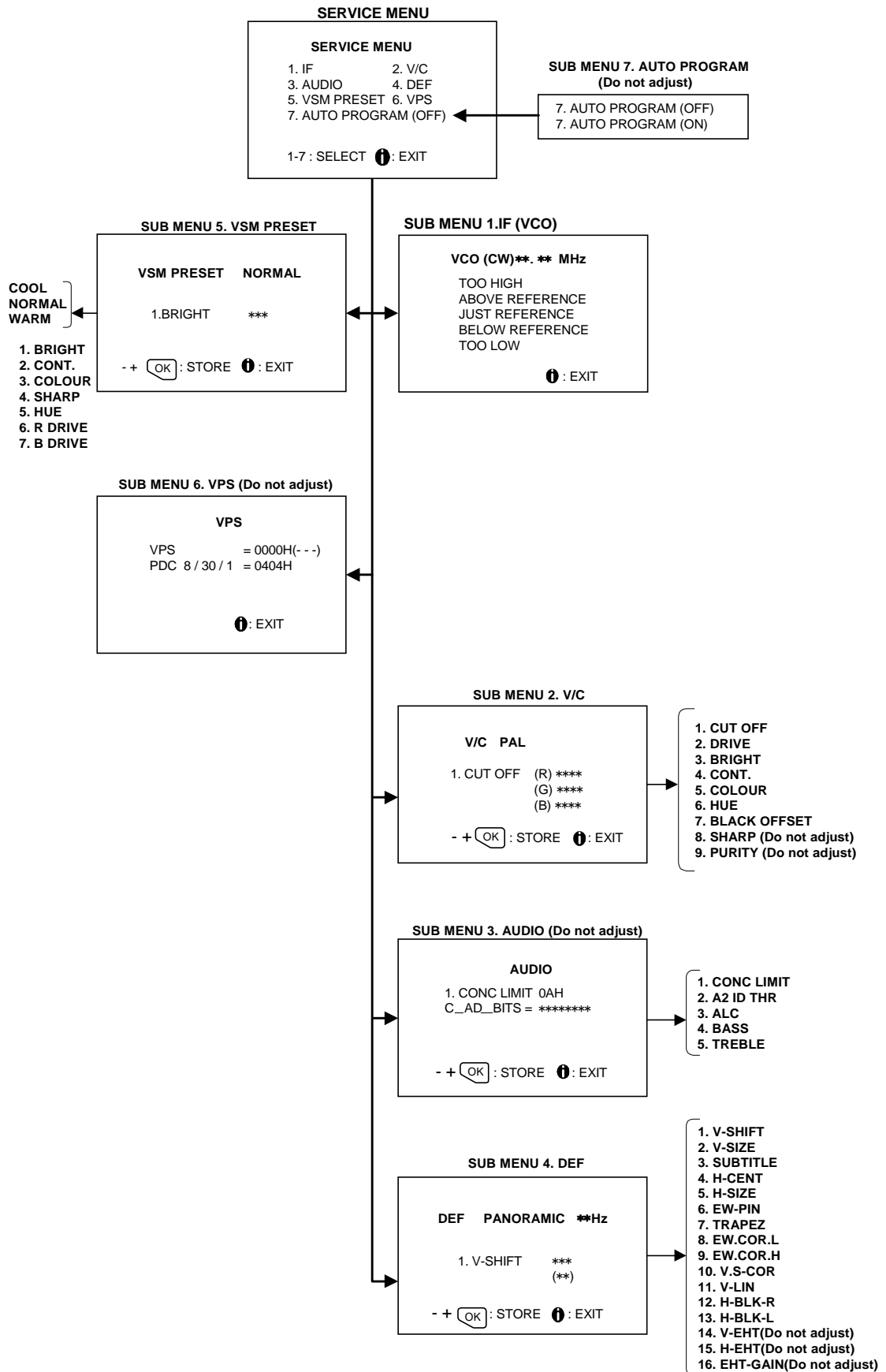

Fig. 3 SUB MENU SCREEN

(3) **Method of Setting**

1) Method of Setting **1.IF**

[VCO]

- ① 1 Key Select 1.IF.
- ② The VCO (CW) screen will be displayed in yellow when the AFC voltage is at a certain level and in blue when it is at other levels.
- ③ INFORMATION Key Return to the SERVICE MENU screen.

2) Method of setting **2.V/C, 3.AUDIO, 4.DEF** and **5.VSM PRESET**.

- ① 2~5 Key Select one from **2. V/C, 3. AUDIO, 4. DEF** and **5. VSM PRESET**.
- ② FUNCTION UP/DOWN Key Select setting items.
- ③ FUNCTION +/- Set (adjust) the setting values of the setting items.
(Use the number keys of the REMOTE CONTROL UNIT for setting of WHITE BALANCE.
For the setting, refer to each item concerned.)
- ④ MENU Key Memorize the setting value.
(Before storing the setting values in memory, do not press the CH, TV, POWER ON / OFF key -
if you do, the values will not be stored in memory.)
- ⑤ INFORMATION Key Return to the **SERVICE MENU** screen.

3) Method of setting **6.VPS** and **7.AUTO PROGRAM**.

6.VPS This mode displayed monitor of VPS systems. **(Do not adjust)**

7.AUTO PROGRAM When the MAIN POWER is turned on with the state of AUTO PROGRAM ON, you get a mode that initializes every existing set value including language selection. Because this mode is set at the factory upon completion of the adjustment, you need not to use it for service. **(Do not adjust in this mode.)**

(4) **Release of SERVICE MENU**

- 1) After completing the setting, return to the SERVICE MENU, then again press the INFORMATION key.

ADJUSTMENTS

CHECKING ITEM

Item	Measuring instrument	Test point	Adjustment part	Description
Check of B1 Power Supply	Signal Generator DC voltmeter Remote Control unit	TP-91(B1) TP-E(↵) [X connector on POWER DEF PWB]		<ol style="list-style-type: none"> 1. Receive any broadcast. 2. Push the "ZOOM" key and select the FULL mode. 3. Select 2. V/C from the SERVICE MENU. 4. Select 1. CUT OFF with Function UP / DOWN key. 5. Show horizontal one line with the 1 key. 6. Turn the SCREEN VR, the whole black screen display. 7. Connect a DC voltmeter to TP-91(B1) and TP-E(↵). 8. Make sure that the voltage is DC144.5 ±2.0V. 9. Readjust the SCREEN VR to appear the horizontal line faintly, and cancel the horizontal line to press the 2 key.
Check of High Voltage	Signal Generator DC voltmeter Remote Control unit	CRT anode Chassis GND		<ol style="list-style-type: none"> 1. Receive any broadcast. 2. Push the "ZOOM" key and select the FULL mode. 3. Select 2. V/C from the SERVICE MENU. 4. Select 1. CUT OFF with Function UP / DOWN key. 5. Show horizontal one line with the 1 key. 6. Turn the SCREEN VR, the whole black screen display. 7. Connect a DC voltmeter to CRT ANODE and chassis GND. 8. Make sure that the voltage is DC 31.0kV ^{+1kV} -1.5kV. 9. Readjust the SCREEN VR to appear the horizontal line faintly, and connect the horizontal line to press 2 key.

ADJUSTMENT OF FOCUS

Item	Measuring instrument	Test point	Adjustment part	Description
Adjustment of FOCUS	Signal generator		FOCUS VR [In FBT]	<ol style="list-style-type: none"> 1. Receive a cross-hatch signal. 2. By turning the FOCUS 2 VR, adjust the to make the vertical lines as fine and sharp as possible. 3. By turning the FOCUS 2 VR, adjust the picture so that the 5th vertical line from left side of the cross-hatch picture becomes thinnest. 4. By turning the FOCUS 1 VR, adjust the 3rd horizontal line from the upper side may become uniform at the line center and its periphery. 5. Carry out adjustment by repeating the steps 3 and 4 about. 6. Make sure that when the screen is darkened, the lines remain in good focus.

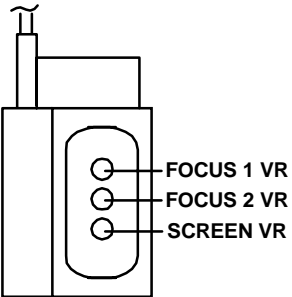

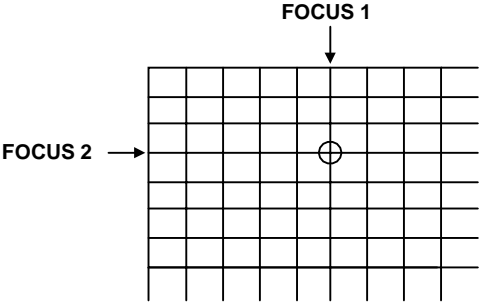

IF CIRCUIT ADJUSTMENT

Item	Measuring instrument	Test point	Adjustment part	Description
Adjustment of VCO	Remote control unit			<ul style="list-style-type: none"> Under normal conditions, no adjustment is required. 1. Receive any broadcast. 2. Select 1.IF from the SERVICE MENU. 3. Check the characters colour of between the "ABOVE REFERENCE" and "BELOW REFERENCE" displayed to yellow.

VCO(CW) ***. ** MHz ← fv

TOO HIGH

ABOVE REFERENCE ← YELLOW

JUST REFERENCE

BELOW REFERENCE

TOO LOW

i : EXIT

VSM PRESET SETTING

Item	Measuring instrument	Test point	Adjustment part	Description
Setting of VSM PRESET	Remote control unit		<ol style="list-style-type: none"> BRIGHT CONT. COLOUR SHARP HUE R DRIVE B DRIVE 	<ol style="list-style-type: none"> Select 5.VSM PRESET from the SERVICE MENU. Select COOL with the MENU key of the remote control unit. Adjust the FUNCTION UP/DOWN and +/- key to bring the set values of 1.BRIGHT ~ 7. B DRIVE to the values shown in the table. Press the MENU key and memorize the set value. Respectively select the VSM PRESET mode for NORMAL and WARM, and make similar adjustment as in 3 above. Press the MENU key and memorize the set value. <p>* Refer to OPERATING INSTRUCTIONS for the PICTURE MODE.</p>

VSM preset mode	COOL	NORMAL	WARM
Setting item			
1. BRIGHT SETTING VALUE	+0	+0	+0
2. CONT. SETTING VALUE	+12	+10	+2
3. COLOUR SETTING VALUE	+6	+0	-2
4. SHARP SETTING VALUE	+0	+0	-2
5. HUE SETTING VALUE	+0	+0	+0
6. R DRIVE SETTING VALUE	-20	+0	+16
7. B DRIVE SETTING VALUE	+23	+0	-13

SETTING VALUES OF VSM PRESET

VIDEO / CHROMA CIRCUIT ADJUSTMENT

The setting (adjustment) using the REMOTE CONTROL UNIT is made on the basis of the initial setting values.
The setting values which adjust the screen to the optimum condition can be different from the initial setting values.

Setting Item (Adjustment Item)		Initial setting value
1. CUTOFF	R	-100
	G	-100
	B	-100
2. DRIVE	R	+0
	B	+0
3. BRIGHT		+0
4. CONT.		-10

Setting item	Colour system	Initial setting value	
		PAL	NTSC 3.58 NTSC 4.43
5. COLOUR		+14	+8
6. HUE		—	+2
7. BLACK OFFSET (Only SECAM)	R-Y	—	—
	B-Y	—	—
8. SHARP (Do not adjust)		-7	←
9. PURITY (Do not adjust)		OFF	—

Item	Measuring instrument	Test point	Adjustment part	Description
Adjustment of WHITE BALANCE (Low Light)	Signal generator		1.CUT OFF (R)*** (G)*** (B)***	<ul style="list-style-type: none"> ● Set the PICTURE MODE to NORMAL. 1. Receive a black and white signal (colour off). 2. Select 2. V/C from the SERVICE MENU. 3. Select 1.CUT OFF with the FUNCTION UP/DOWN key. 4. Push the "ZOOM" key and select the "PANORAMIC" mode. 5. Show one horizontal line with the 1 key. 6. Gradually turn the SCREEN VR from the left end to the right direction to bring one of the red, green or blue colour faintly visible. 7. Press 4~9 key, and bring out the other 2 colours and make one horizontal line visible in white. 8. Turn the SCREEN VR and bring one white horizontal line faintly visible. 9. Press 2 key, turn off 1.CUT OFF screen. 10. Press the MENU key and memorize the set value.
	Remote control unit		SCREEN VR [In FBT]	

Remote Control Unit

H.LINE ON	H.LINE OFF	
↓	↓	
①	②	③
↓	↓	↓
R CUTOFF▲	G CUTOFF▲	B CUTOFF▲
↓	↓	↓
④	⑤	⑥
↓	↓	↓
R CUTOFF▼	G CUTOFF▼	B CUTOFF▼
↓	↓	↓
⑦	⑧	⑨

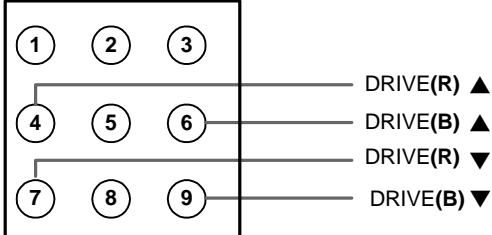
Item	Measuring instrument	Test point	Adjustment part	Description
Adjustment of WHITE BALANCE (High Light)	Signal generator Remote control unit		2.DRIVE (R) * * * (B) * * *	<ul style="list-style-type: none"> ● The adjustment for Low Light WHITE BALANCE should be finished. ● Set the PICTURE MODE to NORMAL. <ol style="list-style-type: none"> 1. Receive a black and white signal (colour off). 2. Select 2.V/C from the SERVICE MENU. 3. Select 2.DRIVE with the FUNCTION UP/DOWN key. 4. Change the screen colour to white with 4 key or 7 key (Drive of Red), 6 key or 9 key (Drive of Blue). 5. Press the MENU key, and memorize the set values.
<div style="display: flex; align-items: center; justify-content: center;"> <div style="border: 1px solid black; padding: 5px; margin-right: 10px;">REMOTE CONTROL UNIT</div>  </div>				
Adjustment of SUB BRIGHT	Remote control unit		3.BRIGHT	<ol style="list-style-type: none"> 1. Receive any broadcast. 2. Select 2.V/C from the SERVICE MENU. 3. Select 3.BRIGHT with the FUNCTION UP/DOWN key. 4. Set the initial setting value with the FUNCTION +/- key. 5. If the brightness is not the best with the initial setting value, make fine adjustment until you get the best brightness. 6. Press the MENU key and memorize the set value.
Adjustment of SUB CONT.	Remote control unit		4.CONT.	<ol style="list-style-type: none"> 1. Receive any broadcast. 2. Select 2.V/C from the SERVICE MENU. 3. Select 4.CONT with the FUNCTION UP/DOWN key. 4. Set the initial setting value with the FUNCTION - / + key. 5. If the contrast is not the best with the initial setting value, make fine adjustment until you get the best contrast. 6. Press the MENU key and memorize the set value.

Item	Measuring instrument	Test point	Adjustment part	Description
Adjustment of SUB COLOUR I	Remote control unit		5.COLOUR (PAL / NTSC)	[Method of adjustment without measuring instrument]
			PAL COLOUR	(PAL COLOUR) 1. Receive PAL broadcast. 2. Select 2.V/C from the SERVICE MENU. 3. Select 5.COLOUR with the FUNCTION UP/DOWN key. 4. Set the initial setting value for PAL COLOUR with the FUNCTION - or + key. 5. If the colour is not the best with the initial set value, make fine adjustment until you get the best colour. 6. Press the MENU key and memorize the set value.
			NTSC COLOUR	(NTSC 3.58 COLOUR) 1. Input a NTSC 3.58MHz COMPOSITE VIDEO signal from the EXT terminal. 2. Make similar fine adjustment of NTSC 3.58 COLOUR in the same manner as for above.
				(NTSC 4.43 COLOUR) 1. When NTSC 3.58 is set, NTSC 4.43 will be automatically set at the respective values.

Item	Measuring instrument	Test point	Adjustment part	Description
Adjustment of SUB COLOUR II	Signal generator	TP-47B TP-E(↕)	5.COLOUR (PAL / NTSC)	[Method of adjustment using measuring instrument]
	Oscilloscope	[CRT SOCKET PWB]	PAL COLOUR	(PAL COLOUR) 1. Receive a PAL full field colour bar signal (75% white). 2. Select 2.V/C from the SERVICE MENU. 3. Select 5.COLOUR with the FUNCTION UP/DOWN key. 4. Set the initial setting value of PAL COLOUR with the FUNCTION - or + key. 5. Connect the oscilloscope between TP-47B and TP-E(↕). 6. Adjust PAL COLOUR and bring the value of (A) in the illustration to the values are shown given below. (Voltage difference between white (W) and blue (B)). 7. Press the MENU key and memorize the setting value.
	Remote control unit		NTSC COLOUR	(NTSC 3.58 COLOUR) 1. Input a NTSC 3.58MHz COMPOSITE VIDEO signal (full field colour bar with 75% white) from the EXT terminal. 2. Set the initial setting value of NTSC 3.58 COLOUR with the FUNCTION +/- key. 3. Adjust NTSC 3.58 COLOUR and bring the value of (A) of the illustration to 0V (W-B) . 4. Press the MENU key and memorize the setting value.

VOLTAGE (W-B)	+2V
----------------------	------------

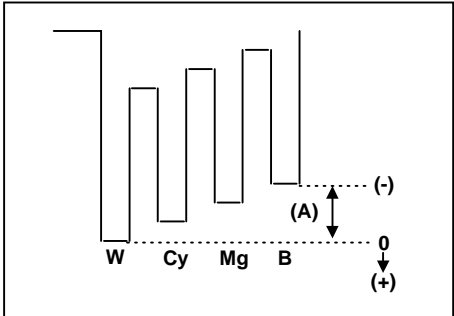

Item	Measuring instrument	Test point	Adjustment part	Description
Adjustment of SUB HUE I	Remote control unit		6.HUE	[Method of adjustment without measuring instrument]
			NTSC 3.58 HUE	[NTSC 3.58 HUE] 1. Input a NTSC 3.58MHz COMPOSITE VIDEO signal (full field colour bar with 75% white) from the EXT terminal. 2. Select 2.V/C from the SERVICE MENU. 3. Select 6. HUE with the FUNCTION UP/DOWN key. 4. Set the initial setting value of NTSC 3.58 HUE with the FUNCTION -/+ key. 5. If you cannot get the best hue with the initial setting value, make fine adjustment until you get the best hue. 6. Press the MENU key and memorize the set value.
Adjustment of SUB HUE II	Signal generator Oscilloscope Remote control unit	TP-47B TP-E(↘) [CRT SOCKET PWB]	6. HUE	[Method of adjustment using measuring instrument]
			NTSC 3.58 HUE	[NTSC 3.58 HUE] 1. Input a NTSC 3.58MHz COMPOSITE VIDEO signal (full field colour bar with 75% white) from the EXT terminal. 2. Select 2.V/C from the SERVICE MENU. 3. Select 6. HUE with the FUNCTION UP/DOWN key. 4. Set the initial setting value of NTSC 3.58 HUE with the FUNCTION - or + key. 5. Connect the oscilloscope between TP-47B and TP-E(↘) 6. Adjust NTSC 3.58 HUE to bring the value of (B) in the illustration to 0V (W-Mg) (voltage difference between white (W) and magenta (Mg)). 7. Press the MENU key and memorize the setting value
			NTSC 4.43 HUE	[NTSC 4.43 HUE] 1. When NTSC 3.58 is set, NTSC 4.43 will be automatically set at the respective values.

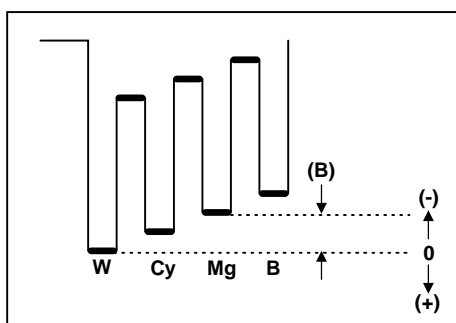

DEFLECTION CIRCUIT ADJUSTMENT

There are 6 modes of the adjustment (1) 50Hz mode (①PANORAMIC ②FULL ③REGULAR ④14:9 ZOOM ⑤16:9 ZOOM ⑥16:9 ZOOM SUB TITLE), (2) 60Hz mode (each aspect mode) depending upon the kind of signals (vertical frequency 50Hz / 60Hz).

- The adjustment using the remote control unit is made on the basis of the initial setting values.
- When the 50Hz PANORAMIC mode has been established, the setting of other modes will be done automatically. However, if the picture quality has not been optimized, adjust each mode again, respectively.
- The setting values which adjust the screen to the optimum condition can be different from the initial setting values.

Initial setting value (1/2)

• Marked * : Fixed value

Setting item	Adjustment name	Initial setting value							
		PANORAMIC		14:9 ZOOM		16:9 ZOOM		16:9 ZOOM SUB TITLE	
		50Hz	60Hz	50Hz	60Hz	50Hz	60Hz	50Hz	60Hz
1. V-SHIFT	Vertical center	+5	-2	+0	+0	-1	0	0	0
2. V-SIZE	Vertical height	+1	-3	+9	+10	+30	+31	+34	+32
3. SUBTITLE *	SUBTITLE BOTTOM Vertical Linearity	0	0	0	0	0	0	+5	+5
4. H-CENT	Horizontal center	-7	+4	0	+0	+0	0	+0	+0
5. H-SIZE	Horizontal width	+5	-1	-12	-13	-13	-12	-13	-12
6. EW-PIN	Side pin correction	-14	-1	-3	-1	-1	+1	-2	-1
7. TRAPEZ	Trapezoidal distortion correction	+0	-2	-1	-1	-1	-1	-1	0
8. EW.COR.L	CORNER PIN correction Low side	-1	+0	+1	+1	+1	+1	+1	+1
9. EW.COR.H	CORNER PIN correction High side	-1	+1	+1	+0	+1	+0	+1	0
10.V.S-COR *	Vertical height correction	+15	+0	-15	-15	-15	-15	-15	-15
11.V-LIN	Vertical Linearity	0	-4	+1	+1	-3	-4	-1	+1
12.H-BLK-R	BLANKING POSITION of Right side	+0	+0	+116	+117	+0	+0	+0	+0
13.H-BLK-L	BLANKING POSITION of Left side	+0	+0	+42	+34	+0	+0	+0	+0
14.V-EHT *	V size correction level caused by EHT change	-2	+0	+0	+0	+0	+0	+0	+0
15.H-EHT *	H size correction level caused by EHT change	-3	+0	+0	+0	+0	+0	+0	+0
16.EHT-GAIN*	Size correction gain caused by EHT change	+0	+0	+0	+0	+0	+0	+0	+0

Initial setting value (2/2)

• Marked * : Fixed value

Setting item	Adjustment name	Initial setting value			
		FULL		REGULAR	
		50Hz	60Hz	50Hz	60Hz
1. V-SHIFT	Vertical center	+0	0	+0	+0
2. V-SIZE	Vertical height	-16	-13	-6	-7
3. SUBTITLE	SUBTITLE BOTTOM Vertical Linearity	0	0	0	0
4. H-CENT	Horizontal center	-1	+0	0	0
5. H-SIZE	Horizontal width	-13	-12	-23	-23
6. EW-PIN	Side pin correction	0	+2	-1	+2
7. TRAPEZ	Trapezoidal distortion correction	0	+1	-1	-1
8. EW.COR.L	CORNER PIN correction Low side	+1	+1	+1	+1
9. EW.COR.H	CORNER PIN correction High side	+1	+0	-1	+0
10.V.S-COR	Vertical height correction	-10	-15	-5	-5
11.V-LIN	Vertical Linearity	+1	0	0	0
12.H-BLK-R	BLANKING POSITION of Right side	+0	+0	+116	+117
13.H-BLK-L	BLANKING POSITION of Left side	+0	+0	+40	+36
14.V-EHT *	Vsize correction level caused by EHT change	+0	+0	+0	+0
15.H-EHT *	Hsize correction level caused by EHT change	+0	+0	+0	+0
16.EHT-GAIN *	Size correction gain caused by EHT change	+0	+0	+0	+0

Item	Measuring instrument	Test point	Adjustment part	Description
Adjustment of V-SHIFT	Signal generator Remote control unit		1.V- SHIFT	<p>[50Hz PANORAMIC mode]</p> <ol style="list-style-type: none"> 1. Receive a circle pattern signal of vertical frequency 50Hz. 2. Select 4.DEF from the SERVICE MENU. 3. Select 1.V-SHIFT with the FUNCTION UP/DOWN key. 4. Adjust V-SHIFT to make A = B. 5. Press the MENU key and memorize the set value. <p>* For JK chassis Set all data except for "PANORAMIC" to "0". Adjust V.CENTER of other aspects with "PANORAMIC" mode while also taking their positions into consideration. If you want to obtain horizontal lines with less noise on the screen, adjust V.LIN instead of "PANORAMIC" mode.</p>
Adjustment of V-SIZE & SUBTITLE			2.V-SIZE 3.SUBTITLE	<ol style="list-style-type: none"> 6. Receive a cross-hatch signal. 7. Select 2.V-SIZE and set the initial setting value. 8. Adjust V-SIZE and make sure that the vertical screen size of the picture size is in the bellow table. 9. Press the MENU key and memorize the set value. 10. When adjust the [SUBTITLE], select "3.SUBTITLE" and adjust to under part of picture size. 11. Input a NTSC VIDEO signal (60Hz) from the EXT terminal, and make sure that the vertical screen size is in the table below. 12. Press the MENU key and memorize the set value.

The diagram shows a rectangular screen with a circle inside. Two horizontal dashed lines are drawn across the circle. The vertical distance from the top edge of the screen to the upper dashed line is labeled 'A'. The vertical distance from the lower dashed line to the bottom edge of the screen is labeled 'B'. Arrows indicate these measurements.

The diagram shows a grid of 10x10 squares. The outer dashed rectangle is labeled 'Screen size' on both horizontal and vertical axes. The inner solid rectangle is labeled 'Picture size 100%' on both horizontal and vertical axes.

ASPECT MODE	PANORAMIC	14 : 9 ZOOM	16 : 9 ZOOM	16 : 9 ZOOM SUB TITLE	FULL	REGULAR
SCREEN TOP	87%	80%	70%	70%	92%	92%
SCREEN BOTTOM	87%	80%	70%	83%	92%	92%

[SCREEN SIZE]

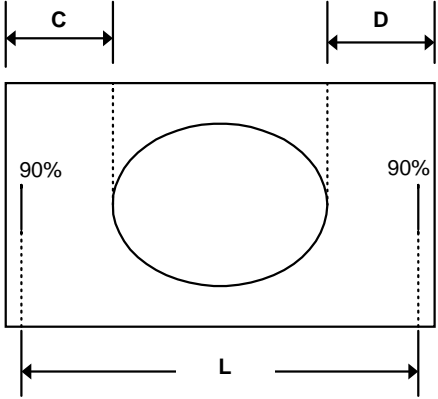
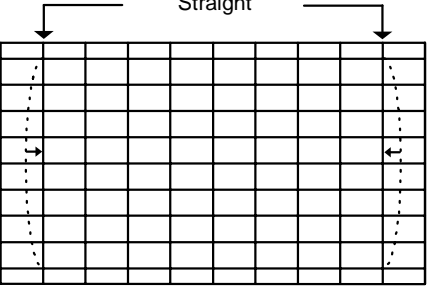
Item	Measuring instrument	Test point	Adjustment part	Description																	
Adjustment of H.CENTER 			4.H-CENT.	6. Receive a circle pattern signal. 7. Select 4.H-CENT and set the initial setting value. 8. Adjust H-CENT to make C=D . 9. Press the MENU key and memorize the set value.																	
Adjustment of H.SIZE			5.H-SIZE	10. Receive a circle pattern signal. 11. Select 5.H-SIZE and set the initial setting value. 12. Adjust H-SIZE and make sure that the horizontal screen size of the picture size is in the below table. 13. Press the MENU key and memorize the set value. ※ The numeric of the REGULAR and 14:9 ZOOM modes are shown the length of the 90% horizontal size position(L) as shown in the figure above. 14. Input a NTSC VIDEO signal (60Hz) from the EXT terminal, and make sure that the horizontal screen size of the each ASPECT mode is in the below table. 15. Press the MENU key and memorize the set value.																	
<table border="1"> <thead> <tr> <th>ASPECT MODE</th> <th>PANORAMIC</th> <th>14:9 ZOOM</th> <th>16:9 ZOOM</th> <th>16:9 ZOOM SUB TITLE</th> <th>FULL</th> <th>REGULAR</th> </tr> </thead> <tbody> <tr> <td rowspan="2">H SIZE</td> <td>PAL=95%</td> <td rowspan="2">L=495mm</td> <td rowspan="2">92%</td> <td rowspan="2">92%</td> <td rowspan="2">92%</td> <td rowspan="2">L=440mm</td> </tr> <tr> <td>NTSC=94%</td> </tr> </tbody> </table>							ASPECT MODE	PANORAMIC	14:9 ZOOM	16:9 ZOOM	16:9 ZOOM SUB TITLE	FULL	REGULAR	H SIZE	PAL=95%	L=495mm	92%	92%	92%	L=440mm	NTSC=94%
ASPECT MODE	PANORAMIC	14:9 ZOOM	16:9 ZOOM	16:9 ZOOM SUB TITLE	FULL	REGULAR															
H SIZE	PAL=95%	L=495mm	92%	92%	92%	L=440mm															
	NTSC=94%																				
[SCREEN SIZE]																					
Adjustment of EW-PIN 			6.EW-PIN	16. Select 6.EW-PIN and set the initial setting value 17. Adjust EW-PIN and make the 2nd vertical lines at the left and right edges of the screen straight. Also make sure that the 3rd vertical lines are straight. 18. Press the MENU key and memorize the set value.																	

Item	Measuring instrument	Test point	Adjustment part	Description
<p>Adjustment of TRAPEZ</p>	<p>Signal generator Remote control unit</p>		<p>7.TRAPEZ</p>	<p>19. Receive a cross-hatch signal. 20. Select 7.TRAPEZ with the FUNCTION UP/DOWN key. 21. Set the initial setting value of TRAPEZ with the FUNCTION - or + key. 22. Adjust TRAPEZ and bring the VERTICAL lines at the right and left edges of the screen parallel . 23. Press the MENU key and memorize the set value.</p>
<p>Adjustment of EW. COR. L/H</p>	<p>Signal generator Remote control unit</p>		<p>8.EW. COR. L 9.EW. COR. H</p>	<p>24. Select 8.EW. COR. L with the FUNCTION UP / DOWN key. 25. Set the initial setting value of EW. COR. L with the FUNCTION - or + key. 26. Adjust EW. COR. L, and bring the straight line at the low corner. 27. Select 9.EW. COR. H with the FUNCTION UP / DOWN key. 28. Set the initial setting value of EW. COR. H with the FUNCTION - or + key. 29. Adjust EW. COR. H, and bring the straight line at the upper corner. 30. Press the MENU key and memorize the set value.</p>

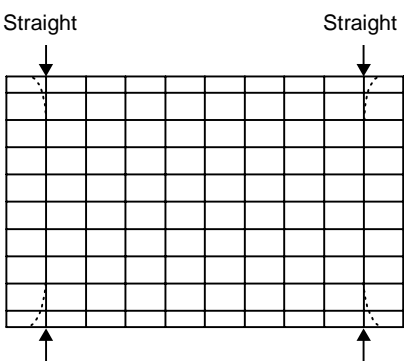
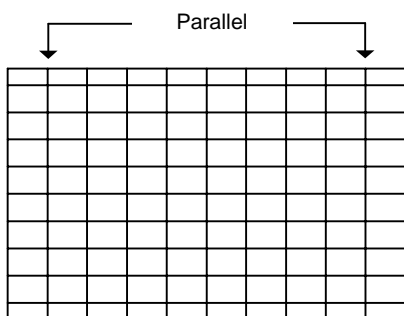

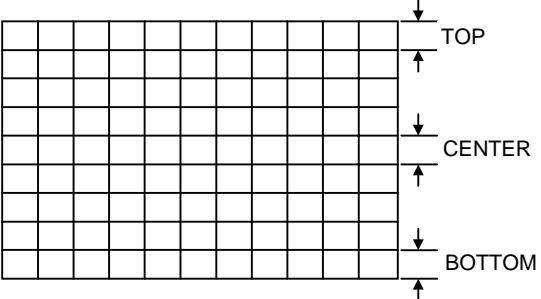
Item	Measuring instrument	Test point	Adjustment part	Description
Adjustment of V-S.COR & V.LINEARITY			10. V-S. COR 11. V-LIN 	<ul style="list-style-type: none"> ● When the vertical linearity has been deteriorated remarkably, perform the following steps. 31. Receive a cross-hatch signal. 32. Select 11.V-LIN with the FUNCTION UP/DOWN key. 33. Set the initial setting value of 11.V-LIN with the FUNCTION - / + key. 34. Select 10.V-S.COR with the FUNCTION UP / DOWN key. 35. Set the initial setting value of 10.V-S.COR with the FUNCTION - / + key. 36. Adjust 11.V-LIN and 10.V-S.COR so that the spaces of each line on TOP, CENTER and BOTTOM become uniform. <p>NOTE :Do not adjust "PANORAMIC" & "16 : 9 ZOOM SUBTITLE" mode.</p> <p>* For JK chassis On account of CRT (ITC), set V-S.COR except for "PANORAMIC" mode to the minimum. When adjusting "PANORAMIC" mode, slightly expand the space at the CENTER while taking the circularity at the CENTER into consideration.</p>
				<p>At first the adjustment in 50Hz-PANORAMIC mode should be done, then the data for the other zoom mode is corrected in the respective value at the same time. And confirm the deflection adjustment initial setting value in 60Hz(NTSC EXT mode) PANORAMIC mode. If the adjustment in 50Hz each zoom mode has been done and stored, the data for the same aspect modes in 60Hz is corrected in the respective value. Only the data for the other aspect mode in 60Hz is corrected for itself.</p>

H. BLANKING ADJUSTMENT

Item	Measuring instrument	Test point	Adjustment part	Description
Adjustment of H.BLANKING			H.BLK Capacitor [On MAIN PWB]	<ol style="list-style-type: none"> 1. Receive the PAL circle pattern signal. 2. Select 4.DEF from the SERVICE MENU. 3. Select the aspect [14:9 ZOOM] mode. 4. Select 12.H-BLK-R with the FUNCTION UP/DOWN key and adjust H-BLANKING so that 92% of the picture on the right side is displayed. 5. Select 13.H-BLK-L with the FUNCTION UP/DOWN key and adjust H-BLANKING so that 92% of the picture on the left side is displayed. 6. Press the MENU key and memorize the set value. 7. Select the aspect [REGULAR] mode. 8. Select 12.H-BLK-R with the FUNCTION UP/DOWN key and adjust H'.BLANKING so that 92% of the picture on the right side is displayed. 9. Select 13.H-BLK-L with the FUNCTION UP/DOWN key and adjust H-BLANKING so that 92% of the picture on the left side is displayed. 10. Press the MENU key and memorize the set value.

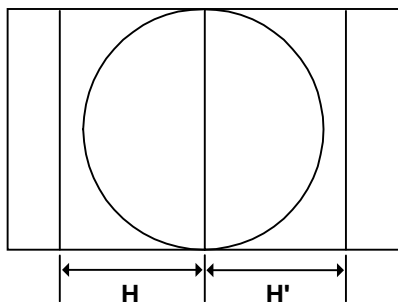

AUDIO CIRCUIT ADJUSTMENT

- Do not touch 3.AUDIO(1. CONC LIMIT, 2. A2 ID THR, 3. ALC, 4. BASS, 5. TREBLE) of the SERVICE MENU as it requires no adjustment.

3. AUDIO

Setting item	Variable range	fixed value
1. CONC LIMIT (<i>Do not adjust</i>)	00H ~ FFH	0AH
2. A2 ID THR (<i>Do not adjust</i>)	00H ~ FFH	19H
3. ALC (<i>Do not adjust</i>)	20MSEC → 2SEC → 4SEC → 8SEC	—————
4. BASS (<i>Do not adjust</i>)	-17 ~ +17	+0
5. TREBLE (<i>Do not adjust</i>)	-17 ~ +17	+0

AV28S2EKGR / AV28S2EKBL
AV28S2EIQR / AV28S2EIBL



JVC

VICTOR COMPANY OF JAPAN, LIMITED

HOME AV NETWORK BUSINESS UNIT 1106 Heta, Iwai-city, Ibaraki-prefecture, 306-0698, Japan

AV28S2EKGR-U #4 AV28S2EKBL-U #4
AV28S2EIGR-U #4 AV28S2EIBL-U #4



Printed in Japan
VP 0103
DP2051